

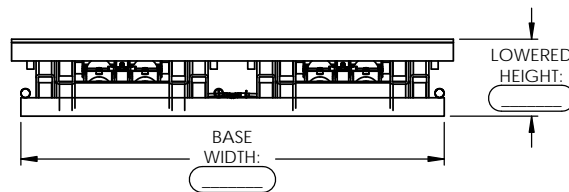

PART #: LSH20X-XXX-XX-XXXXX

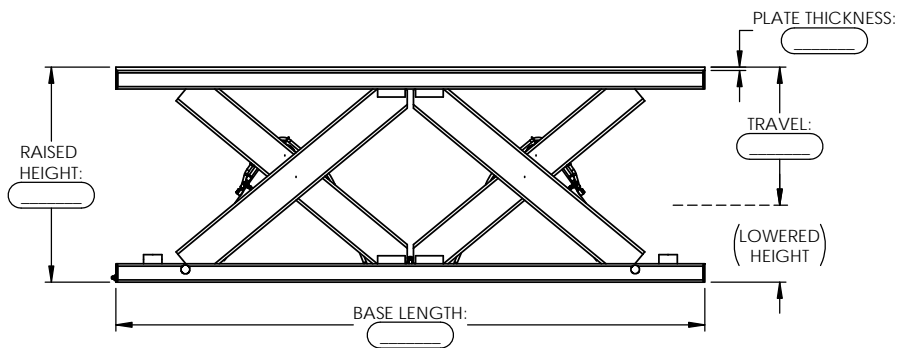
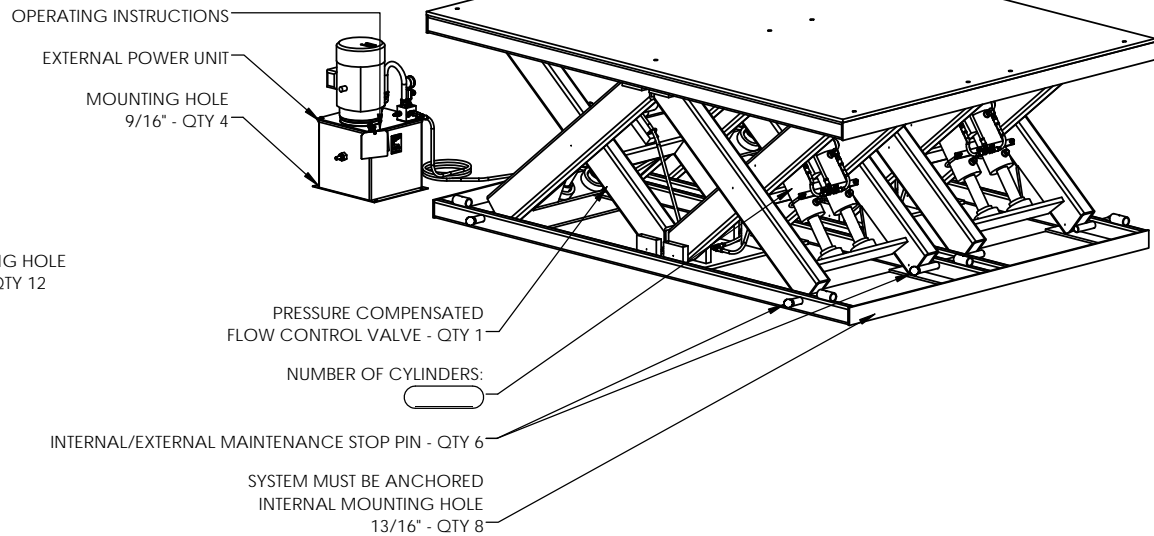
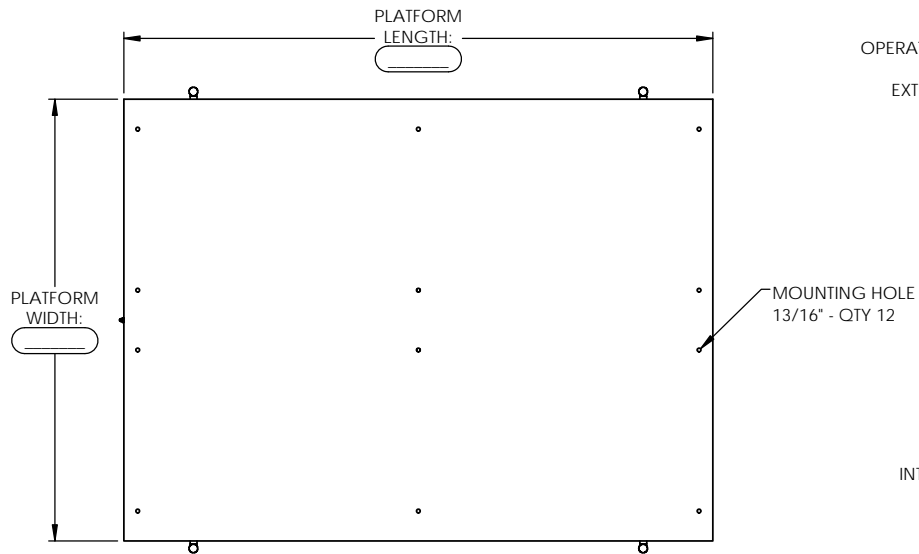

**SPECIFICATIONS - STANDARD**

**CAPACITY:** 5,000 - 40,000 LBS  
 ALL LOADS MUST BE EVENLY DISTRIBUTED, LIFT MAY NOT RAISED TO FULL HEIGHT WITH MAXIMUM CAPACITY LOAD

**NOTE:**  
 FOR OVERALL LIFT DIMENSIONS AND NUMBER OF CYLINDERS, PLEASE REFERENCE THE CHART TAB UNDER THE LIFT TYPE ON WEBPAGE. FOR ADDITIONAL QUESTIONS, PLEASE CONTACT OUR SALES STAFF.

THE NEED FOR SAFETY DEVICES VARIES WITH EACH APPLICATION OF THIS PRODUCT THIS DRAWING MAY NOT INCLUDE ALL APPROPRIATE SAFETY DEVICES FOR YOUR APPLICATION. NOTE: SOME DETAILS ARE NOT INCLUDED ON THIS DRAWING FOR MORE DETAILED SPECIFICATIONS, PLEASE INQUIRE <b>PROPRIETARY</b>	TOLERANCES UNLESS OTHERWISE NOTED X ± .250 .XX ± .125 .XXX ± 0.030 .XXXX ± 0.0050 ANGLE ± 1°	 2760 RIDGEWAY COURT • WALLED LAKE, MI 48390-1662 • www.enkon.pro DESCRIPTION: LIFT SCISSOR HYDRAULIC
	THE INFORMATION CONTAINED ON THIS DRAWING IS PROPRIETARY. IT IS THE SOLE PROPERTY OF HERKULES EQUIPMENT CORPORATION. ANY REPRODUCTION IN PART OR AS A WHOLE WITHOUT THE WRITTEN PERMISSION OF HERKULES EQUIPMENT CORPORATION IS PROHIBITED AND MAY BE UNLAWFUL.	

PART #: LSH20X-XXX-XX-XXXXX

NOTES:

1. LIFT SYSTEM TYPE:  
HYDRAULIC SCISSOR LIFT SYSTEM - ELECTRIC
2. HYDRAULIC POWER UNIT:  
UP: POWER  
DOWN: GRAVITY (24 VDC SOLENOID)  
MANUAL RELEASE: NOT INCLUDED
3. CONTROLLER: OPTIONAL
4. CONTROLLER MOUNT: OPTIONAL
5. CONTROLLER HOSE: 6 FEET
6. CONTROLLER CABLE: OPTIONAL
7. SKIRT:  
OPTIONAL  
(ADD 3-1/2 INCHES PER SIDE TO BASE  
OF LIFT DIMENSIONS FOR SKIRTING)
8. COLOR:  
LIFT: HERKULES SAFETY ORANGE  
SCISSORS: HERKULES SAFETY WHITE  
CONTROLLER: OPTIONAL
9. SAFETY FEATURES:  
PRESSURE COMPENSATED FLOW CONTROL VALVE - QTY 1  
INTERNAL/EXTERNAL MAINTENANCE STOP PIN - QTY 6
10. WEIGHT: 11,580 LBS (APPROXIMATE)
11. CYCLE SPEED:  
AVERAGE SPEED: CUSTOMER DEFINED  
SPEED UP: CUSTOMER DEFINED  
SPEED DOWN: CUSTOMER DEFINED
12. DUTY CYCLE:  
SHIFTS / DAY: CUSTOMER DEFINED  
HOURS / SHIFT: CUSTOMER DEFINED  
DAYS / WEEK: CUSTOMER DEFINED  
CYCLES / DAY: CUSTOMER DEFINED  
WEEKS / YEAR: CUSTOMER DEFINED  
CYCLES / YEAR: CUSTOMER DEFINED
13. OTHER:
  - a. E-STOP: INCLUDED
  - b. BREAKER BOX: OPTIONAL
  - c. MOTOR CONNECTOR PLUGS: OPTIONAL
  - b. FIELD WIRING: OPTIONAL
  - c. MOTOR CONNECTOR PLUGS: OPTIONAL
  - d. LIMIT SWITCHES: OPTIONAL

14. BEARINGS LUBED FOR LIFE.
15. TESTING PLAN: CYCLE TESTING WITH RATED LOAD FOR MINIMUM OF 10 CYCLES.
16. PROJECT TIMING IS SUBJECT TO DELIVERY OF PUMPS AND CYLINDERS. CONFIRMED DELIVERY DATE TO BE DETERMINED AFTER FINAL DESIGN APPROVAL.
17. THE LIFT IS A HYDRAULIC POWERED SYSTEM. WITH HIGH ANNUAL USAGE, THE HYDRAULIC SYSTEM WILL HAVE SOME SEEPAGE AND WILL REQUIRE REGULAR MAINTENANCE.

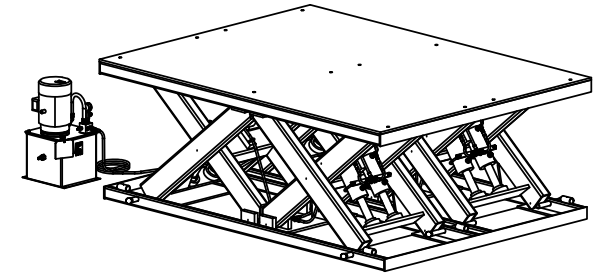

THE NEED FOR SAFETY DEVICES VARIES WITH EACH APPLICATION OF THIS PRODUCT THIS DRAWING MAY NOT INCLUDE ALL APPROPRIATE SAFETY DEVICES FOR YOUR APPLICATION.		TOLERANCES UNLESS OTHERWISE NOTED X ± .250 .XX ± .125 .XXX ± 0.030 .XXXX ± 0.0050 ANGLE ± 1°	 2760 RIDGEWAY COURT • WALL LAKE, MI 48390-1662 • www.enkon.pro
NOTE: SOME DETAILS ARE NOT INCLUDED ON THIS DRAWING FOR MORE DETAILED SPECIFICATIONS, PLEASE INQUIRE			
PROPRIETARY		DESCRIPTION: LIFT SCISSOR HYDRAULIC	
THE INFORMATION CONTAINED ON THIS DRAWING IS PROPRIETARY. IT IS THE SOLE PROPERTY OF HERKULES EQUIPMENT CORPORATION. ANY REPRODUCTION IN PART OR AS A WHOLE WITHOUT THE WRITTEN PERMISSION OF HERKULES EQUIPMENT CORPORATION IS PROHIBITED AND MAY BE UNLAWFUL.		DRN: TEP	PART NO.: LSH20X-XXX-XX-XXXXX
DATE: 5-18-18	CHKD BY:	DWG NO.:	REV: SHEET: 2 of 2