

PART # 13805

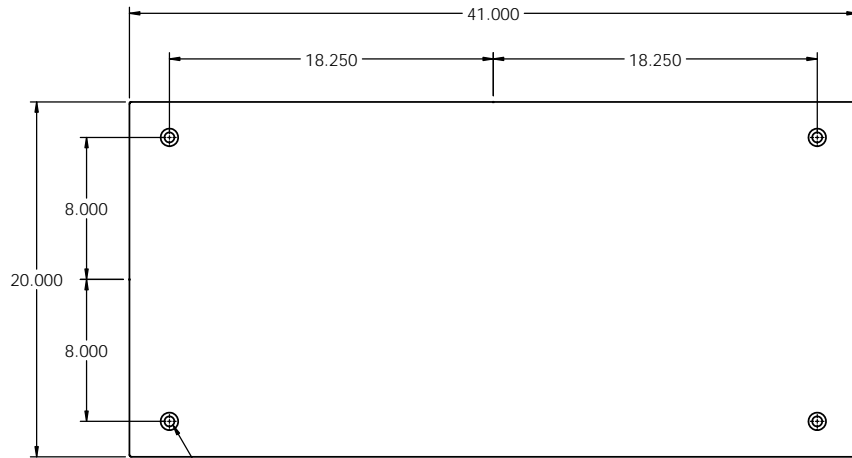

4 X C'SINK FOR 1/2 FHSC

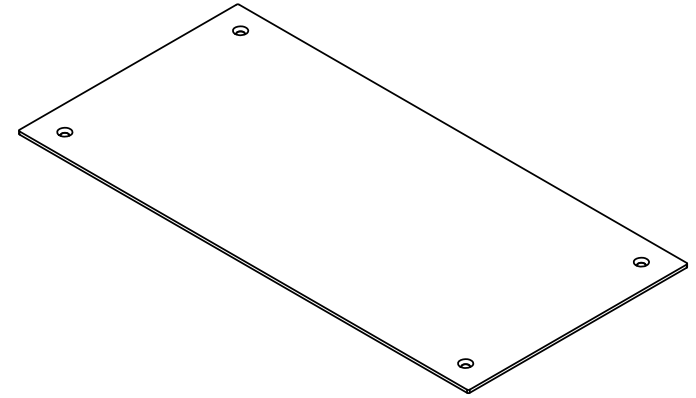
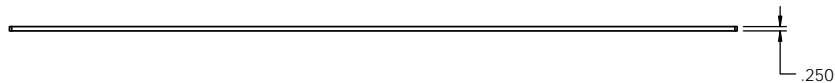

**SPECIFICATIONS - STANDARD**

CAPACITY: 1,000 - 3,000 LBS  
 COMPATIBILITY: LIFT: ALS04  
 TILT: NONE  
 LIFT & TILT: NONE  
 COLOR: HERKULES SAFETY ORANGE  
 SAFETY FEATURES: NONE  
 WEIGHT: 58 LBS (APPROXIMATE)

THE NEED FOR SAFETY DEVICES VARIES WITH EACH APPLICATION OF THIS PRODUCT THIS DRAWING MAY NOT INCLUDE ALL APPROPRIATE SAFETY DEVICES FOR YOUR APPLICATION.  
 NOTE: SOME DETAILS ARE NOT INCLUDED ON THIS DRAWING FOR MORE DETAILED SPECIFICATIONS, PLEASE INQUIRE  
**PROPRIETARY**  
 THE INFORMATION CONTAINED ON THIS DRAWING IS PROPRIETARY. IT IS THE SOLE PROPERTY OF HERKULES EQUIPMENT CORPORATION. ANY REPRODUCTION IN PART OR AS A WHOLE WITHOUT THE WRITTEN PERMISSION OF HERKULES EQUIPMENT CORPORATION IS PROHIBITED AND MAY BE UNLAWFUL.

TOLERANCES UNLESS OTHERWISE NOTED  
 X ± .250  
 .XX ± .125  
 .XXX ± 0.030  
 .XXXX ± 0.0050  
 ANGLE ± 1°



DESCRIPTION: PLATFORM - 20 X 41 X 1/4

DRN: BKH	PART NO.: 13805
DATE: 11/18/16	CHKD BY: [ ]
DWG NO.: 02095747	REV: [ ]
SHEET: 1 of 1	

PART # 13785

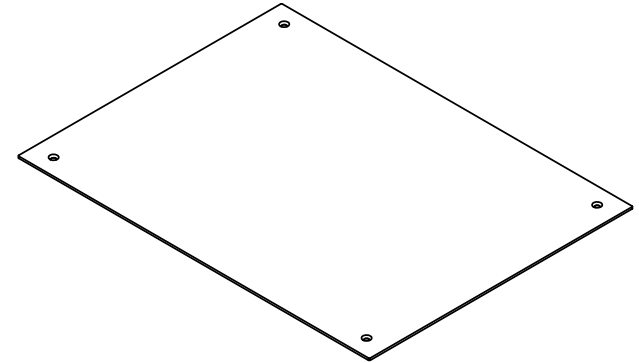
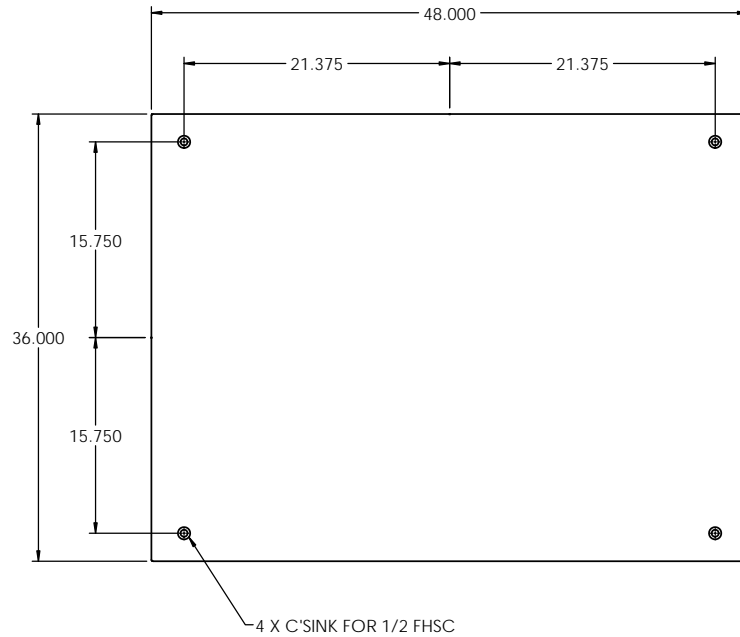

SPECIFICATIONS - STANDARD

CAPACITY: 1,000 - 3,000 LBS  
 COMPATIBILITY: LIFT: ALS01, ALS03  
 TILT: NONE  
 LIFT & TILT: NONE  
 COLOR: HERKULES SAFETY ORANGE  
 SAFETY FEATURES: NONE  
 WEIGHT: 122 LBS (APPROXIMATE)

THE NEED FOR SAFETY DEVICES VARIES WITH EACH APPLICATION OF THIS PRODUCT THIS DRAWING MAY NOT INCLUDE ALL APPROPRIATE SAFETY DEVICES FOR YOUR APPLICATION.

NOTE: SOME DETAILS ARE NOT INCLUDED ON THIS DRAWING FOR MORE DETAILED SPECIFICATIONS, PLEASE INQUIRE

**PROPRIETARY**

THE INFORMATION CONTAINED ON THIS DRAWING IS PROPRIETARY. IT IS THE SOLE PROPERTY OF HERKULES EQUIPMENT CORPORATION. ANY REPRODUCTION IN PART OR AS A WHOLE WITHOUT THE WRITTEN PERMISSION OF HERKULES EQUIPMENT CORPORATION IS PROHIBITED AND MAY BE UNLAWFUL.

TOLERANCES UNLESS OTHERWISE NOTED  
 X ± .250  
 .XX ± .125  
 .XXX ± 0.030  
 .XXXX ± 0.0050  
 ANGLE ± 1°



DESCRIPTION: PLATFORM - 36 X 48 X 1/4

DRN: BKH  
 DATE: 11/18/16

PART NO.: 13785

CHKD BY: DWG NO.: 02085715 REV: SHEET: 1 of 1

PART # 13427

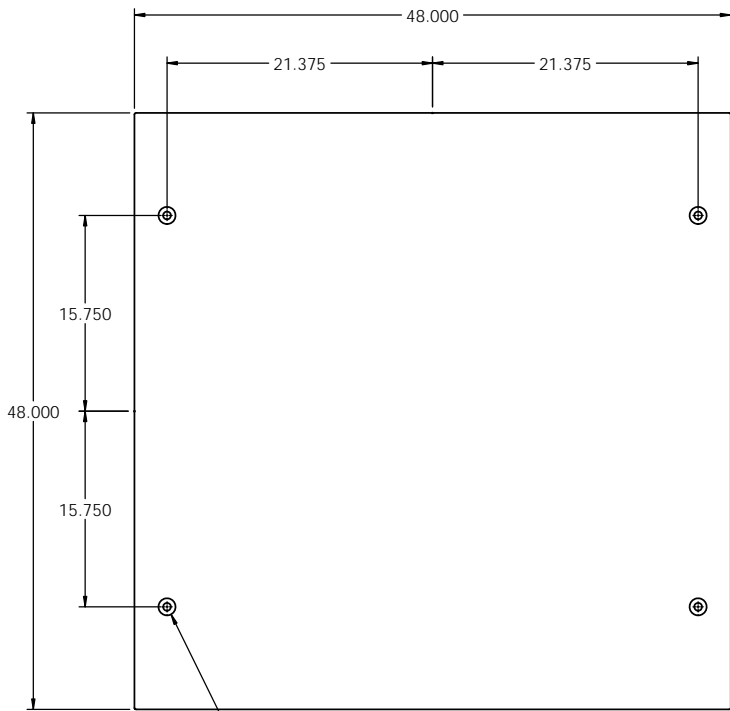

4 X C'SINK FOR 1/2 FHSC

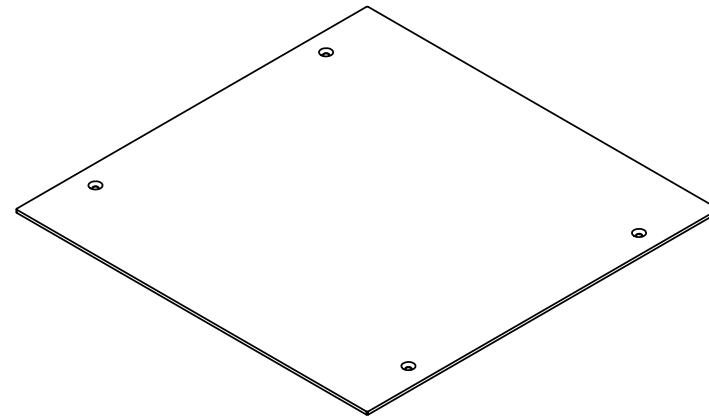
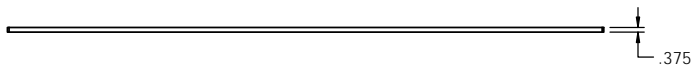

SPECIFICATIONS - STANDARD

CAPACITY: 1,000 - 3,000 LBS  
 COMPATIBILITY: LIFT: ALS01, ALS03  
 TILT: NONE  
 LIFT & TILT: NONE  
 COLOR: HERKULES SAFETY ORANGE  
 SAFETY FEATURES: NONE  
 WEIGHT: 245 LBS (APPROXIMATE)

THE NEED FOR SAFETY DEVICES VARIES WITH EACH APPLICATION OF THIS PRODUCT THIS DRAWING MAY NOT INCLUDE ALL APPROPRIATE SAFETY DEVICES FOR YOUR APPLICATION.

NOTE: SOME DETAILS ARE NOT INCLUDED ON THIS DRAWING FOR MORE DETAILED SPECIFICATIONS, PLEASE INQUIRE

**PROPRIETARY**

THE INFORMATION CONTAINED ON THIS DRAWING IS PROPRIETARY. IT IS THE SOLE PROPERTY OF HERKULES EQUIPMENT CORPORATION. ANY REPRODUCTION IN PART OR AS A WHOLE WITHOUT THE WRITTEN PERMISSION OF HERKULES EQUIPMENT CORPORATION IS PROHIBITED AND MAY BE UNLAWFUL.

TOLERANCES UNLESS OTHERWISE NOTED  
 X ± .250  
 .XX ± .125  
 .XXX ± 0.030  
 .XXXX ± 0.0050  
 ANGLE ± 1°



DESCRIPTION: PLATFORM - 48 X 48 X 3/8

DRN: BKH  
 DATE: 11/18/16

PART NO.: 13427

CHKD BY: DWG NO.: 02085158 REV: SHEET: 1 of 1

PART #: 13806

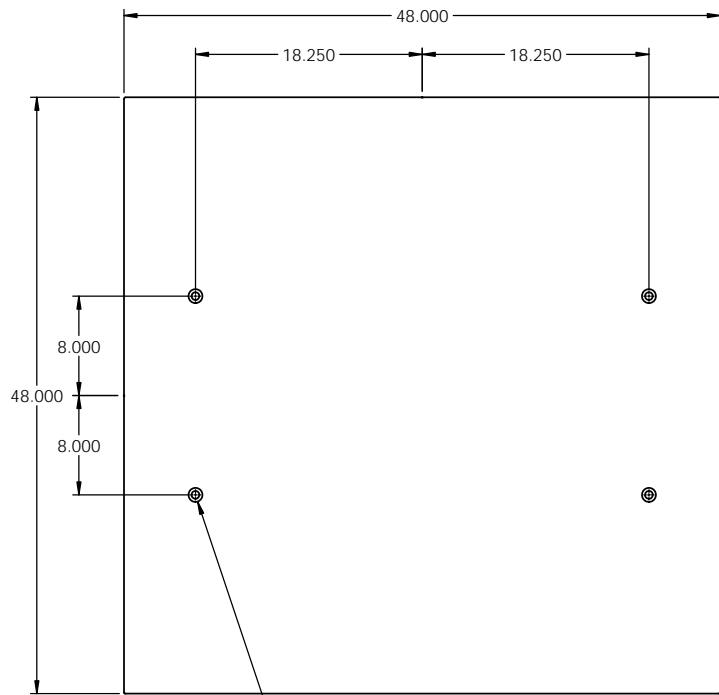

4 X C'SINK FOR 1/2 FHDC

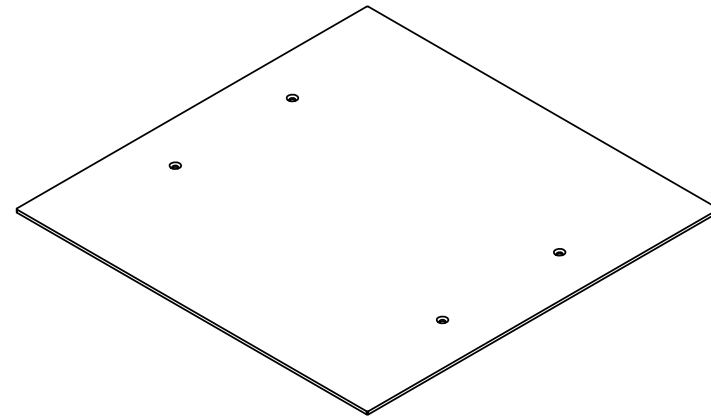
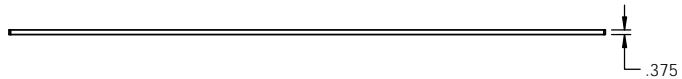

**SPECIFICATIONS - STANDARD**

CAPACITY: 1,000 - 3,000 LBS  
 COMPATIBILITY: LIFT: ALS04  
 TILT: NONE  
 LIFT & TILT: NONE  
 COLOR: HERKULES SAFETY ORANGE  
 SAFETY FEATURES: NONE  
 WEIGHT: 245 LBS (APPROXIMATE)

THE NEED FOR SAFETY DEVICES VARIES WITH EACH APPLICATION OF THIS PRODUCT THIS DRAWING MAY NOT INCLUDE ALL APPROPRIATE SAFETY DEVICES FOR YOUR APPLICATION.

NOTE: SOME DETAILS ARE NOT INCLUDED ON THIS DRAWING FOR MORE DETAILED SPECIFICATIONS, PLEASE INQUIRE

**PROPRIETARY**

THE INFORMATION CONTAINED ON THIS DRAWING IS PROPRIETARY. IT IS THE SOLE PROPERTY OF HERKULES EQUIPMENT CORPORATION. ANY REPRODUCTION IN PART OR AS A WHOLE WITHOUT THE WRITTEN PERMISSION OF HERKULES EQUIPMENT CORPORATION IS PROHIBITED AND MAY BE UNLAWFUL.

TOLERANCES UNLESS OTHERWISE NOTED

X ± .250  
 XX ± .125  
 XXX ± 0.030  
 .XXXX ± 0.0050  
 ANGLE ± 1°



DESCRIPTION: PLATFORM - 48 X 48 X 3/8

DRN: BKH  
 DATE: 11/18/16

PART NO.: 13806

CHKD BY: DWG NO.: 02095749 REV: SHEET: 1 of 1

PART #: 16529

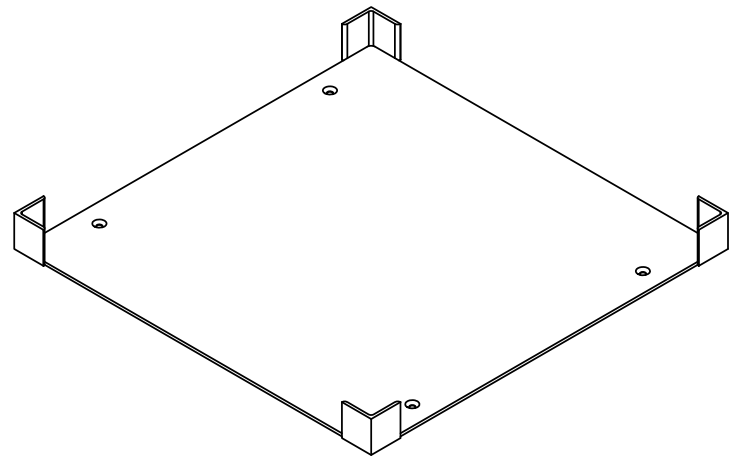
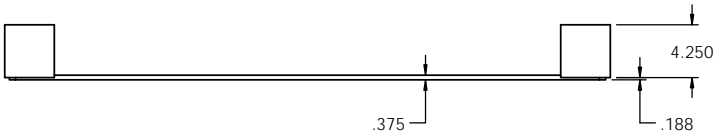
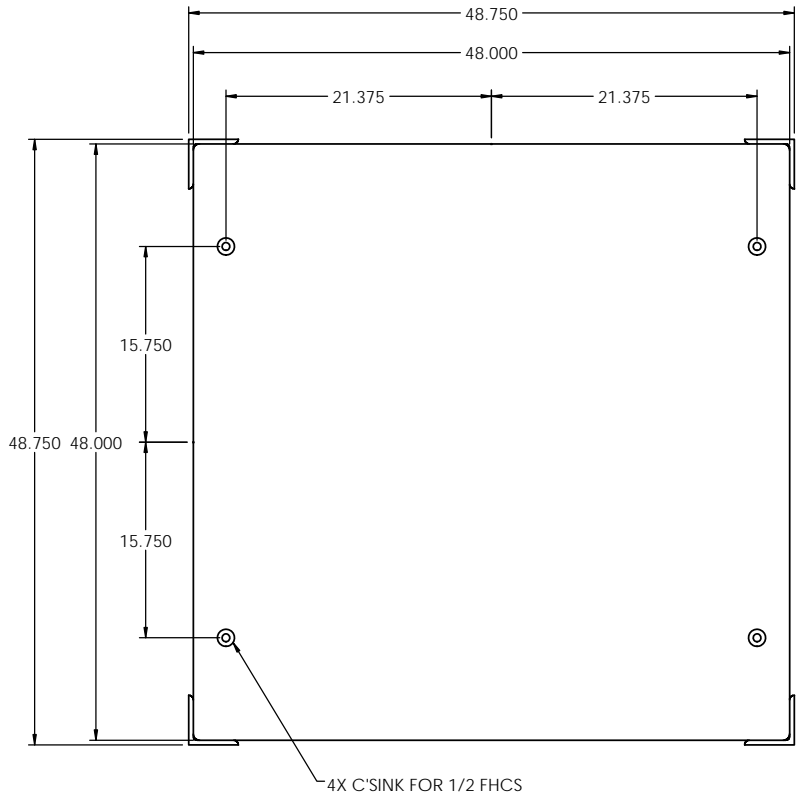

SPECIFICATIONS - STANDARD

CAPACITY: 1,000 - 3,000 LBS  
 COMPATIBILITY: LIFT: ALS01, ALS03  
 TILT: NONE  
 LIFT & TILT: NONE  
 COLOR: HERKULES SAFETY ORANGE  
 SAFETY FEATURES: GUSSETS  
 WEIGHT: 260 LBS (APPROXIMATE)

THE NEED FOR SAFETY DEVICES VARIES WITH EACH APPLICATION OF THIS PRODUCT THIS DRAWING MAY NOT INCLUDE ALL APPROPRIATE SAFETY DEVICES FOR YOUR APPLICATION.  
 NOTE: SOME DETAILS ARE NOT INCLUDED ON THIS DRAWING FOR MORE DETAILED SPECIFICATIONS, PLEASE INQUIRE  
**PROPRIETARY**  
 THE INFORMATION CONTAINED ON THIS DRAWING IS PROPRIETARY. IT IS THE SOLE PROPERTY OF HERKULES EQUIPMENT CORPORATION. ANY REPRODUCTION IN PART OR AS A WHOLE WITHOUT THE WRITTEN PERMISSION OF HERKULES EQUIPMENT CORPORATION IS PROHIBITED AND MAY BE UNLAWFUL.

TOLERANCES UNLESS OTHERWISE NOTED  
 X ± .250  
 XX ± .125  
 XXX ± 0.030  
 XXXX ± 0.0050  
 ANGLE ± 1°



DESCRIPTION: PLATFORM - 48 X 48 X 3/8

DRN: BKH	PART NO.: 16529
DATE: 11/18/16	CHD BY:      DWG NO.: 20151039      REV:      SHEET: 1 of 1

PART #: 16531

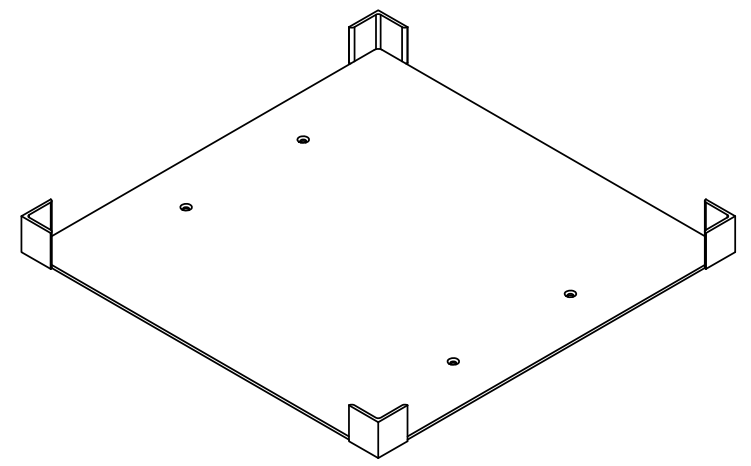
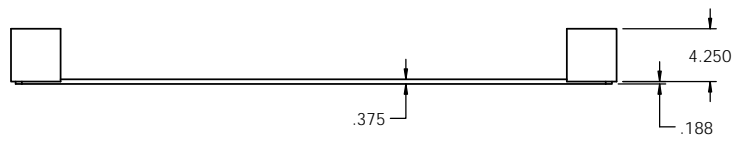
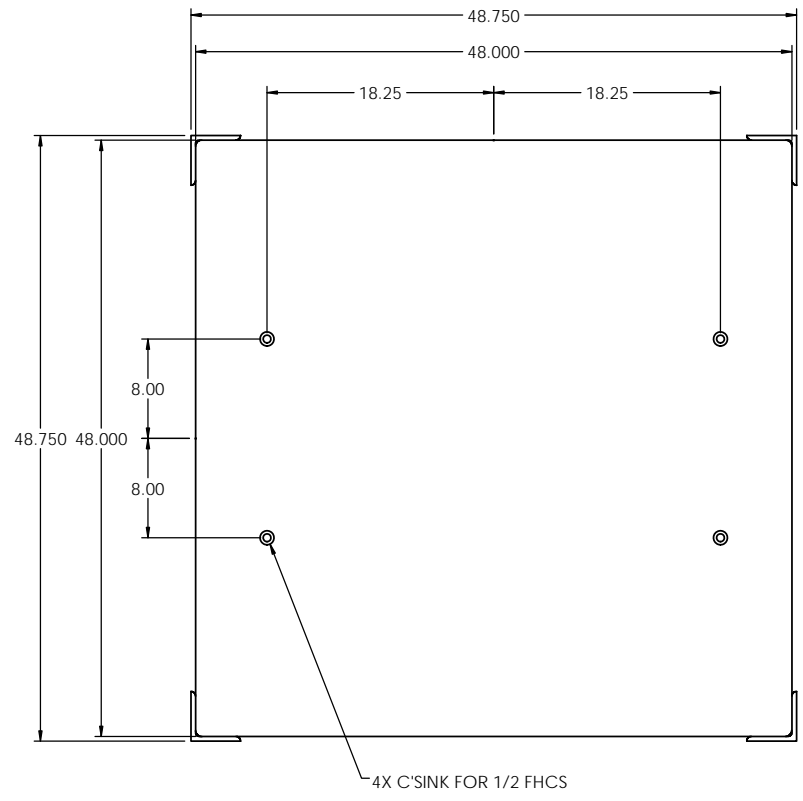

**SPECIFICATIONS - STANDARD**  
 CAPACITY: 1,000 - 3,000 LBS  
 COMPATIBILITY: LIFT: ALS04  
 TILT: NONE  
 LIFT & TILT: NONE  
 COLOR: HERKULES SAFETY ORANGE  
 SAFETY FEATURES: GUSSETS  
 WEIGHT: 260 LBS (APPROXIMATE)

THE NEED FOR SAFETY DEVICES VARIES WITH EACH APPLICATION OF THIS PRODUCT THIS DRAWING MAY NOT INCLUDE ALL APPROPRIATE SAFETY DEVICES FOR YOUR APPLICATION. NOTE: SOME DETAILS ARE NOT INCLUDED ON THIS DRAWING FOR MORE DETAILED SPECIFICATIONS, PLEASE INQUIRE. <b>PROPRIETARY</b>	TOLERANCES UNLESS OTHERWISE NOTED X ± .250 .XX ± .125 .XXX ± 0.030 .XXXX ± 0.0050 ANGLE ± 1°	 2760 RIDGEWAY COURT • WALLED LAKE, MI 48390-1662 • www.enkon.pro	
		DESCRIPTION: PLATFORM - 48 X 48 X 3/8	
THE INFORMATION CONTAINED ON THIS DRAWING IS PROPRIETARY. IT IS THE SOLE PROPERTY OF HERKULES EQUIPMENT CORPORATION. ANY REPRODUCTION IN PART OR AS A WHOLE WITHOUT THE WRITTEN PERMISSION OF HERKULES EQUIPMENT CORPORATION IS PROHIBITED AND MAY BE UNLAWFUL.	DRN: BKH	PART NO.: 16531	
DATE: 11/18/16	CHD BY:	DWG NO.: 20151042	REV: SHEET: 1 of 1

PART #: 13801

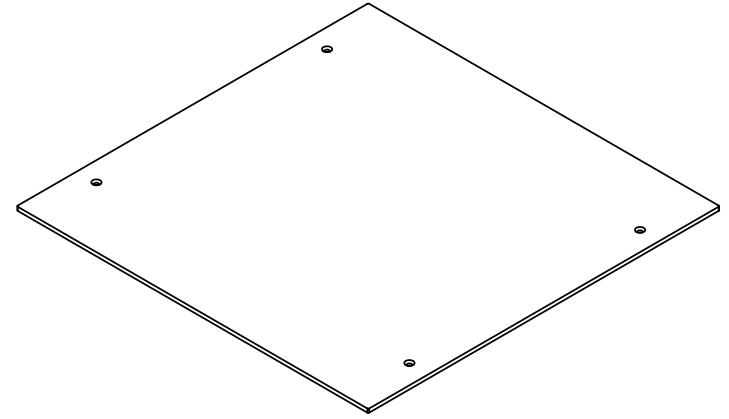
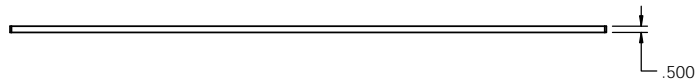
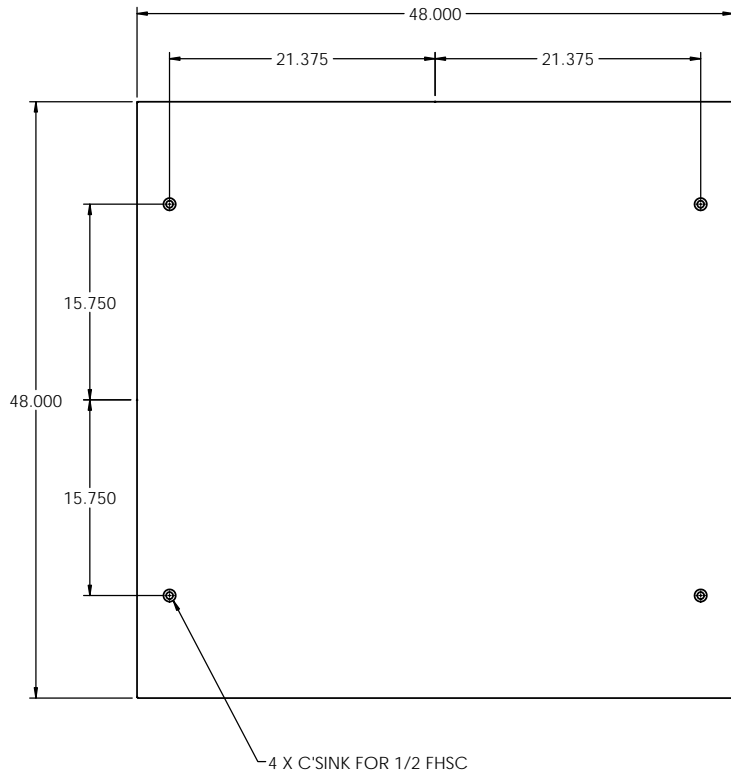

SPECIFICATIONS - STANDARD

CAPACITY: 1,000 - 6,000 LBS  
 COMPATIBILITY: LIFT: ALS01, ALS02, ALS03  
 TILT: NONE  
 LIFT & TILT: NONE  
 COLOR: HERKULES SAFETY ORANGE  
 SAFETY FEATURES: NONE  
 WEIGHT: 327 LBS (APPROXIMATE)

THE NEED FOR SAFETY DEVICES VARIES WITH EACH APPLICATION OF THIS PRODUCT THIS DRAWING MAY NOT INCLUDE ALL APPROPRIATE SAFETY DEVICES FOR YOUR APPLICATION.

NOTE: SOME DETAILS ARE NOT INCLUDED ON THIS DRAWING FOR MORE DETAILED SPECIFICATIONS, PLEASE INQUIRE

**PROPRIETARY**

THE INFORMATION CONTAINED ON THIS DRAWING IS PROPRIETARY. IT IS THE SOLE PROPERTY OF HERKULES EQUIPMENT CORPORATION. ANY REPRODUCTION IN PART OR AS A WHOLE WITHOUT THE WRITTEN PERMISSION OF HERKULES EQUIPMENT CORPORATION IS PROHIBITED AND MAY BE UNLAWFUL.

TOLERANCES UNLESS OTHERWISE NOTED

X ± .250  
 .XX ± .125  
 .XXX ± 0.030  
 .XXXX ± 0.0050  
 ANGLE ± 1°



DESCRIPTION: PLATFORM - 48 X 48 X 1/2

DRN: BKH  
 DATE: 11/18/16

PART NO.: 13801

CHKD BY: DWG NO.: 02095742 REV: SHEET: 1 of 1

PART #: 13807

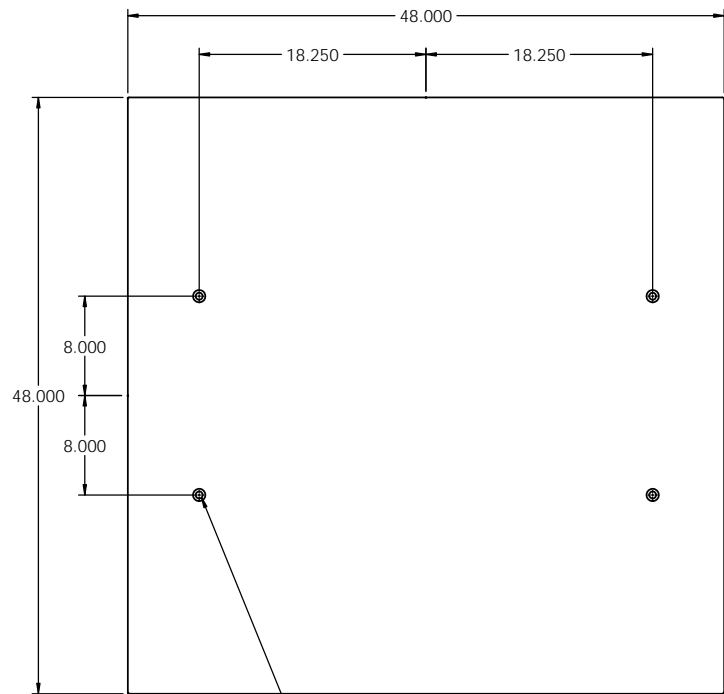

4 X C'SINK FOR 1/2 FHSC

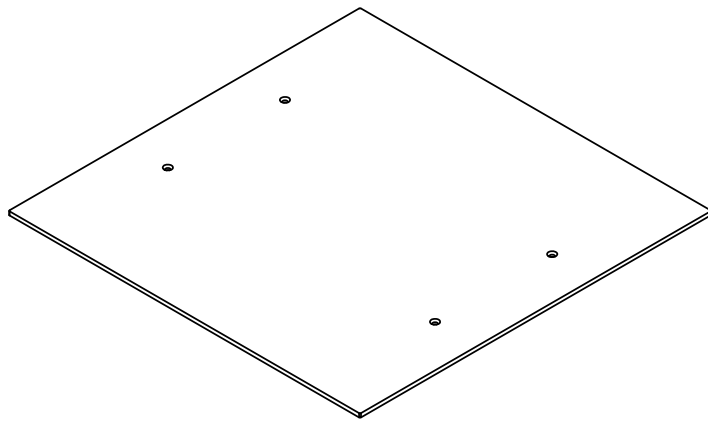
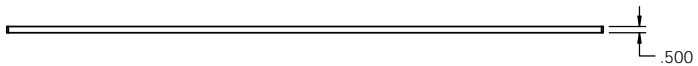

**SPECIFICATIONS - STANDARD**  
 CAPACITY: 1,000 - 3,000 LBS  
 COMPATIBILITY: LIFT: ALS04  
 TILT: NONE  
 LIFT & TILT: NONE  
 COLOR: HERKULES SAFETY ORANGE  
 SAFETY FEATURES: NONE  
 WEIGHT: 327 LBS (APPROXIMATE)

THE NEED FOR SAFETY DEVICES VARIES WITH EACH APPLICATION OF THIS PRODUCT THIS DRAWING MAY NOT INCLUDE ALL APPROPRIATE SAFETY DEVICES FOR YOUR APPLICATION.  
 NOTE: SOME DETAILS ARE NOT INCLUDED ON THIS DRAWING FOR MORE DETAILED SPECIFICATIONS, PLEASE INQUIRE  
**PROPRIETARY**  
 THE INFORMATION CONTAINED ON THIS DRAWING IS PROPRIETARY. IT IS THE SOLE PROPERTY OF HERKULES EQUIPMENT CORPORATION. ANY REPRODUCTION IN PART OR AS A WHOLE WITHOUT THE WRITTEN PERMISSION OF HERKULES EQUIPMENT CORPORATION IS PROHIBITED AND MAY BE UNLAWFUL.

TOLERANCES UNLESS OTHERWISE NOTED  
 X ± .250  
 .XX ± .125  
 .XXX ± 0.030  
 .XXXX ± 0.0050  
 ANGLE ± 1°



DESCRIPTION: PLATFORM - 48 X 48 X 1/2

DRN: BKH	PART NO.: 13807
DATE: 11/18/16	CHKD BY: _____
DWG NO.: 02095751	REV: _____
SHEET: 1 of 1	



PART #: 17071

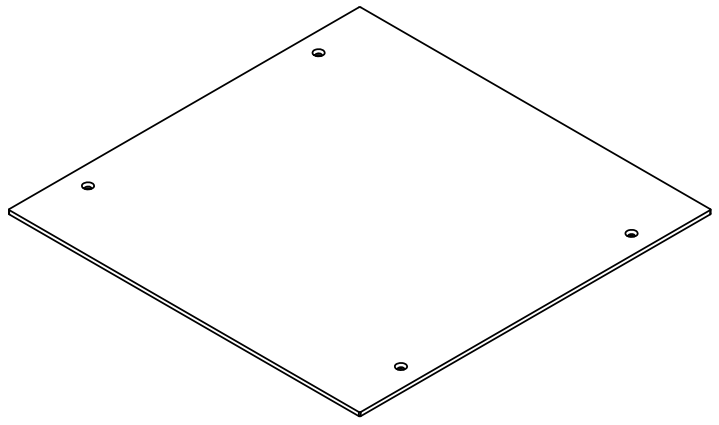
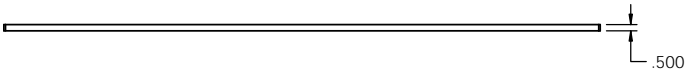
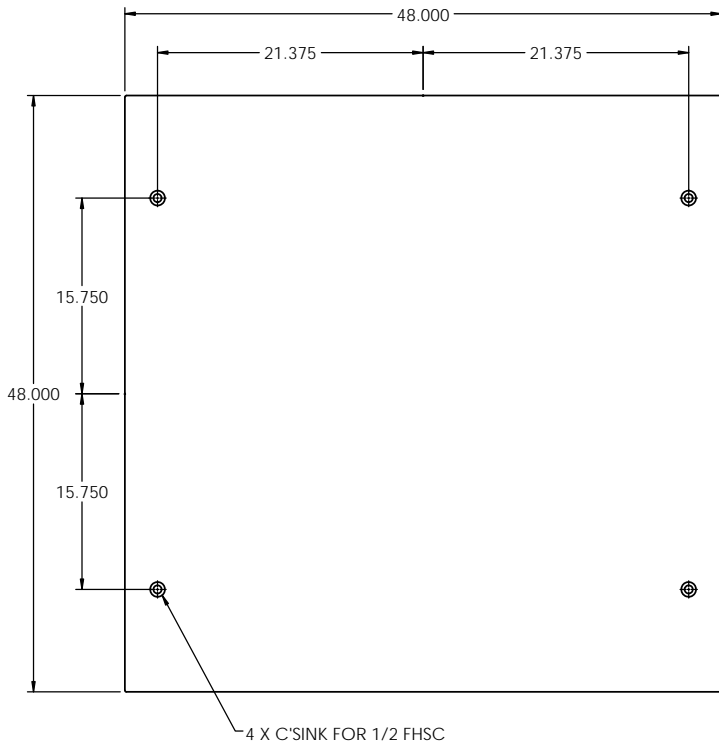

SPECIFICATIONS - STANDARD

CAPACITY: 1,000 - 6,000 LBS  
 COMPATIBILITY: LIFT: ALS05  
 TILT: NONE  
 LIFT & TILT: NONE  
 COLOR: STAINLESS STEEL  
 SAFETY FEATURES: NONE  
 WEIGHT: 327 LBS (APPROXIMATE)

THE NEED FOR SAFETY DEVICES VARIES WITH EACH APPLICATION OF THIS PRODUCT THIS DRAWING MAY NOT INCLUDE ALL APPROPRIATE SAFETY DEVICES FOR YOUR APPLICATION.  
 NOTE: SOME DETAILS ARE NOT INCLUDED ON THIS DRAWING FOR MORE DETAILED SPECIFICATIONS, PLEASE INQUIRE  
**PROPRIETARY**  
 THE INFORMATION CONTAINED ON THIS DRAWING IS PROPRIETARY. IT IS THE SOLE PROPERTY OF HERKULES EQUIPMENT CORPORATION. ANY REPRODUCTION IN PART OR AS A WHOLE WITHOUT THE WRITTEN PERMISSION OF HERKULES EQUIPMENT CORPORATION IS PROHIBITED AND MAY BE UNLAWFUL.

TOLERANCES UNLESS OTHERWISE NOTED  
 X ± .250  
 XX ± .125  
 XXX ± 0.030  
 XXXX ± 0.0050  
 ANGLE ± 1°



DESCRIPTION: PLATFORM - 48 X 48 X 1/2 SS

DRN: TEP	PART NO.: 17071
DATE: 1/10/17	CHKD BY:      DWG NO.: 20162226      REV:      SHEET: 1 of 1